

(A,02): N Tullrock.mdl (..\c pauli\)

cut 306 .mm

N Tüllrock
1x Hinterrock

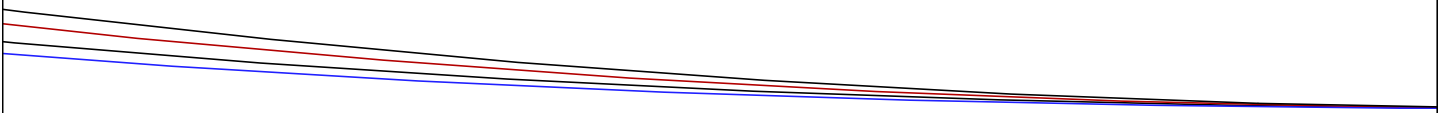

(A,03): N Tüllrock.mdl (..\c pauli\)

hintere Mitte Bruch

Vordere Mitte Bruch

Krüse III

N Tüllrock
1x Vorderrock

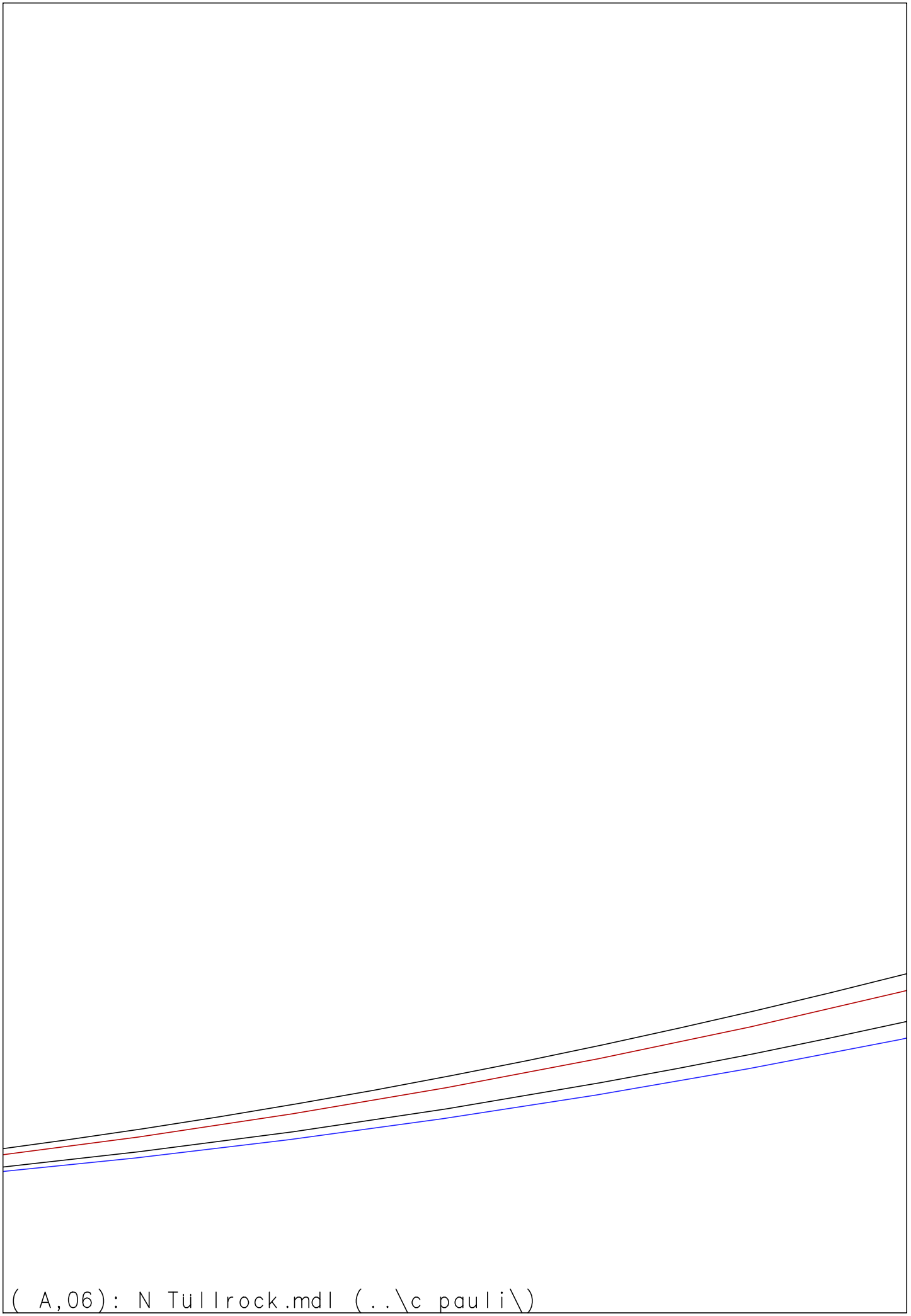

(A,06): N Tullrock.mdl (..\c pauli\)

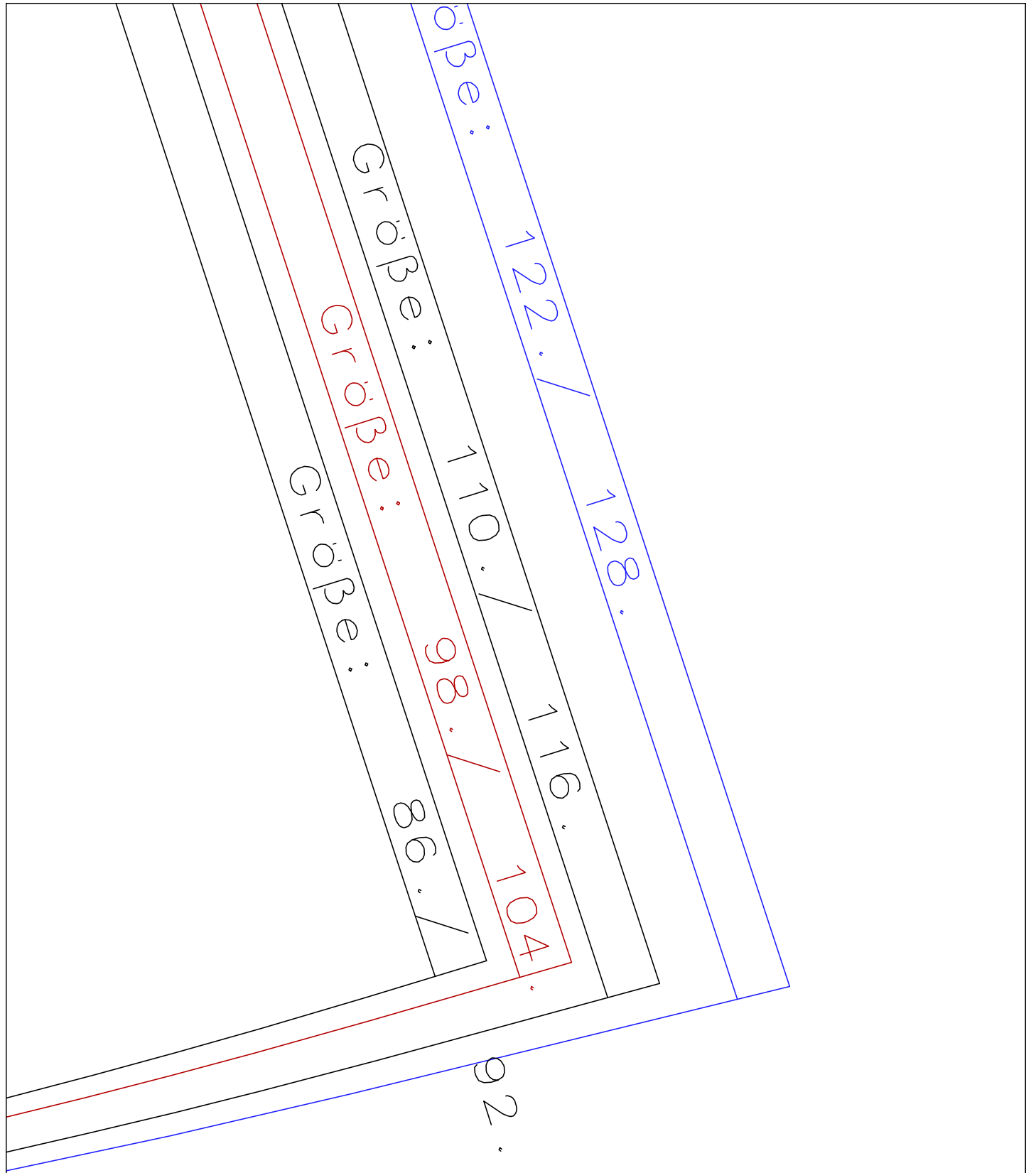

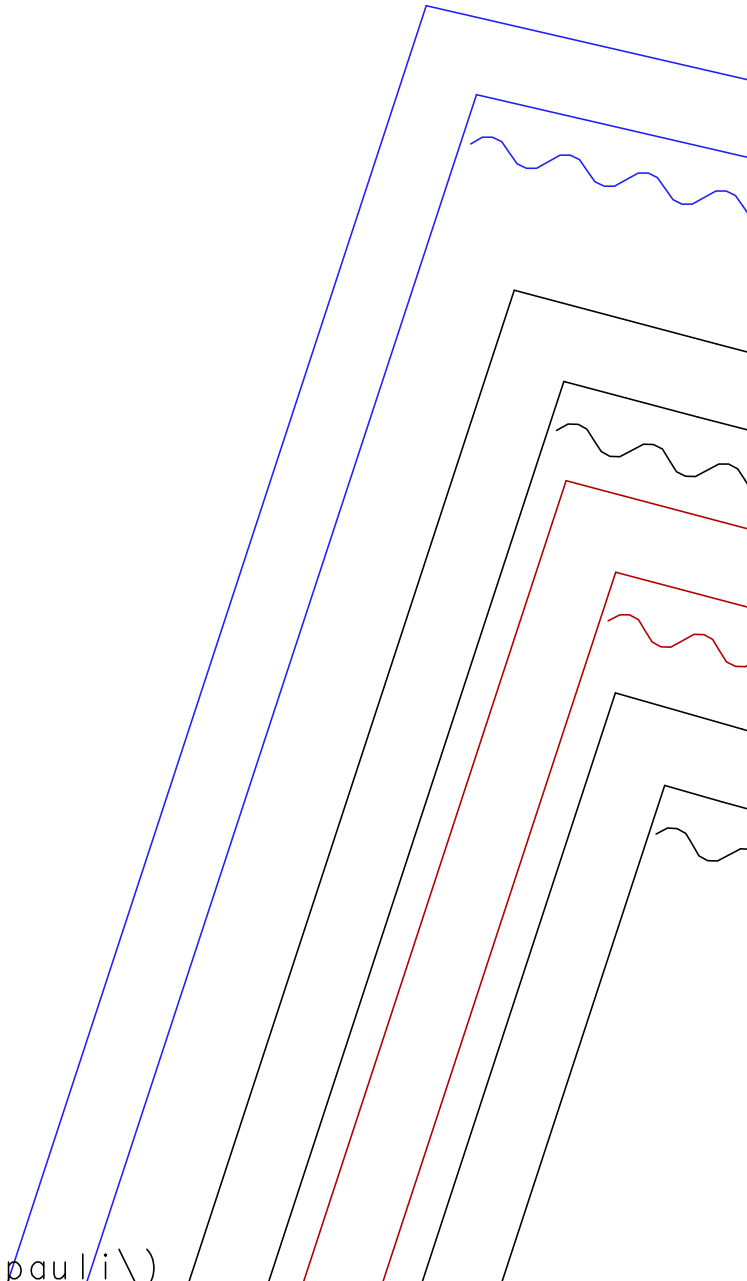
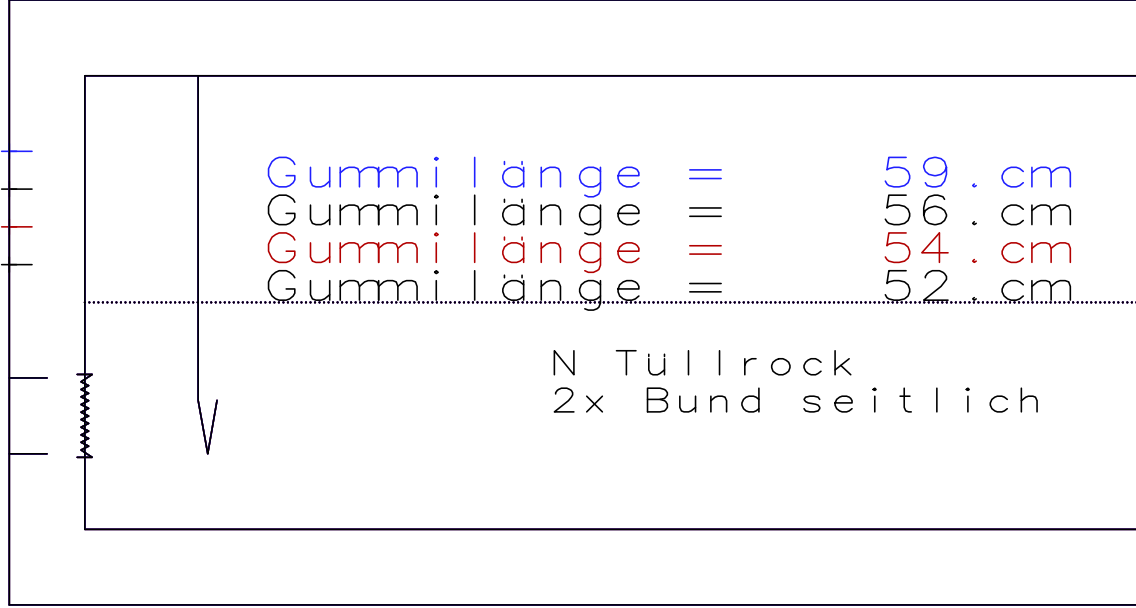

	Größe: 86./ 92.		
	Größe: 98./ 104.		
	Größe: 110./ 116.		
	Größe: 122./ 128.		

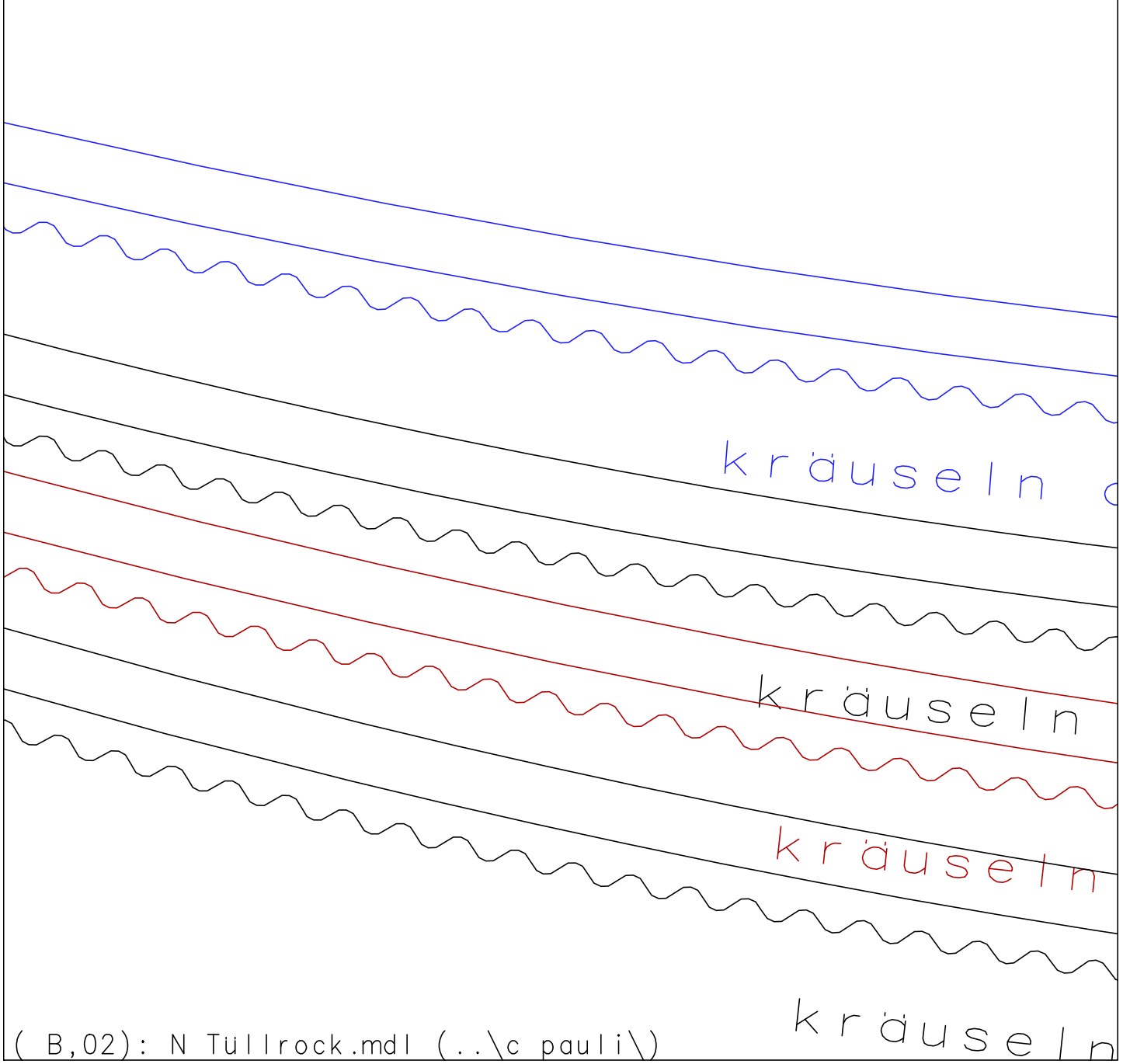

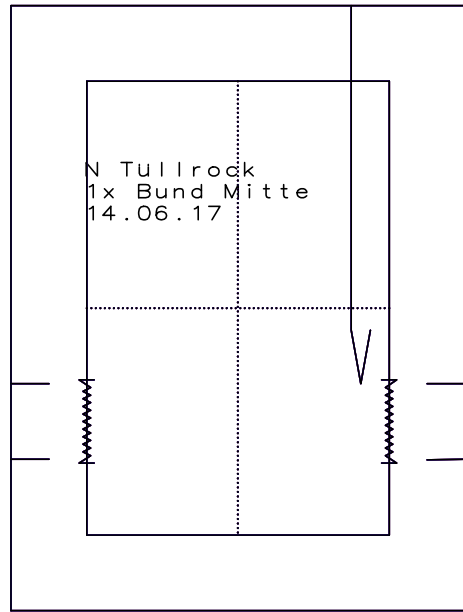

auf 352.mm

auf 330.mm

auf 318.mm

Zur eigenen Sicherheit:
Kontrollfenster nachmessen!

Seitenlänge 10 cm
4 inches

Größe: 86./ 92.

~~Größe: 98./ 104.~~

~~Größe: 110./ 116.~~

~~Größe: 122./ 128.~~

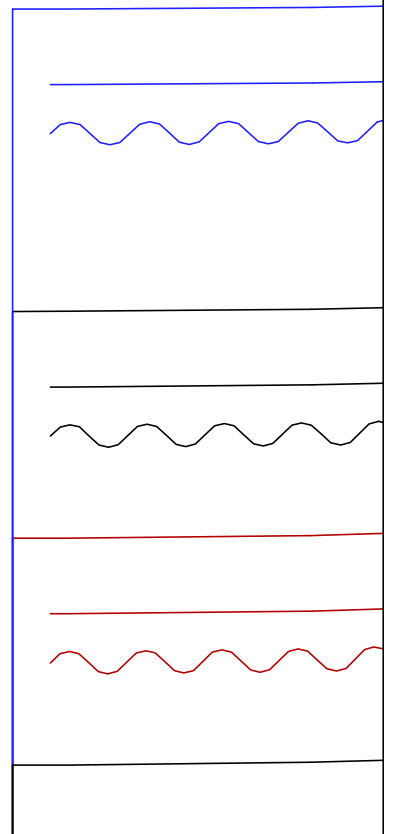
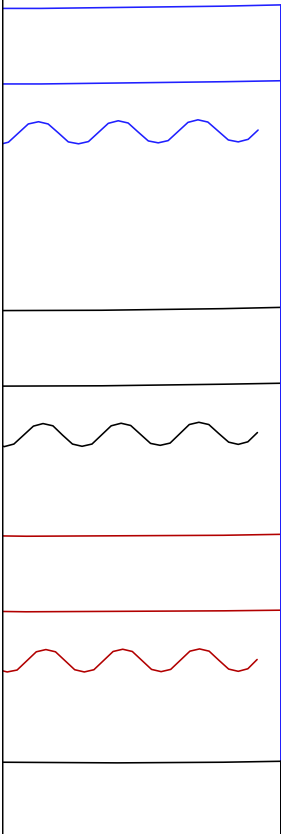

Handwritten practice lines on a page. The page features several sets of horizontal lines, each consisting of a top straight line, a middle wavy line, and a bottom straight line. The lines are colored blue, black, red, and black from top to bottom. The word "Kräusel" is written in the same color as the wavy line in each set. At the bottom left, there is a file path: "(B,05): N Tullrock.mdt (. . \c pauli\)", and at the bottom right, the letters "ln d" are visible.

Kräusel

Kräusel

Kräusel

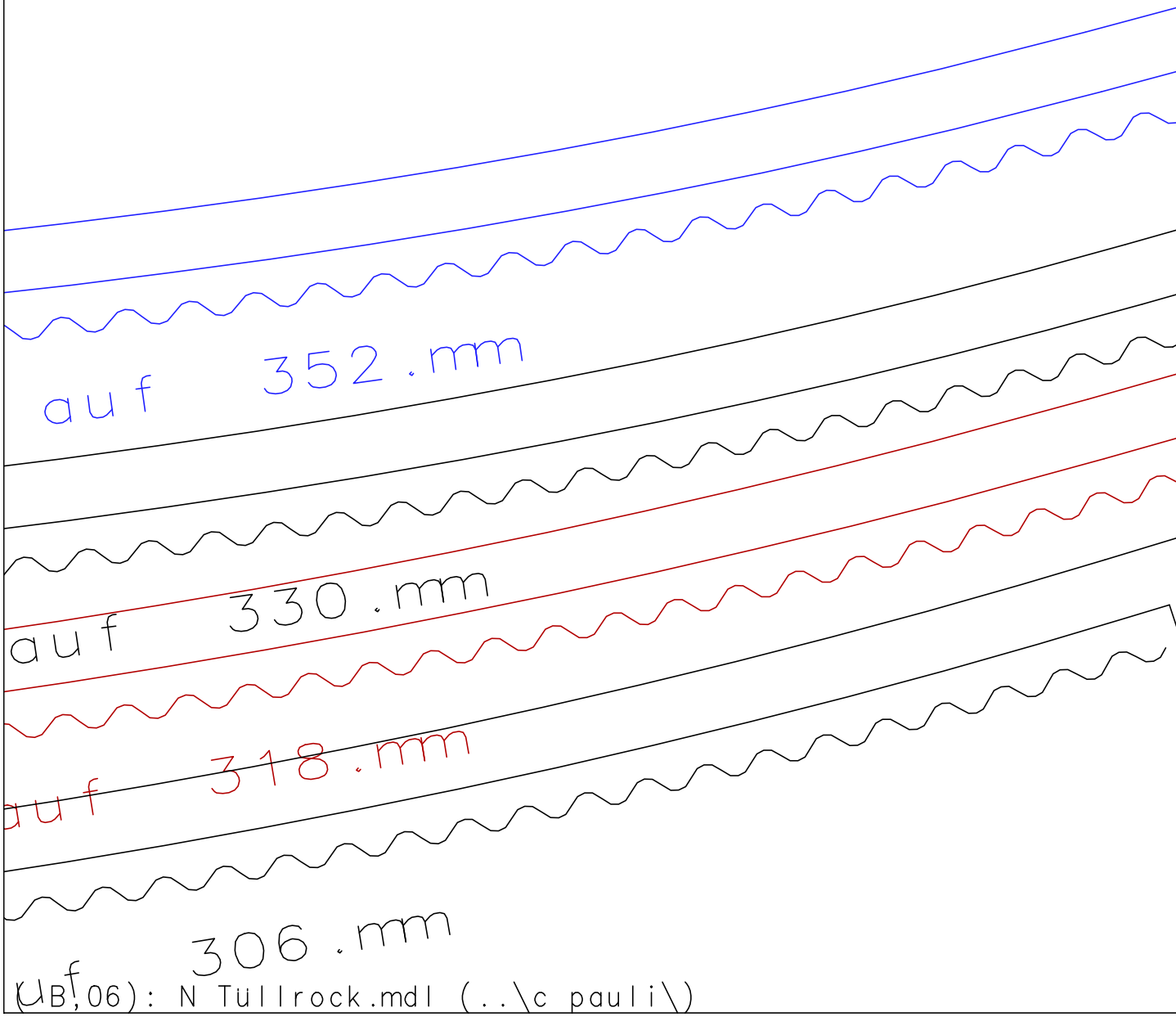

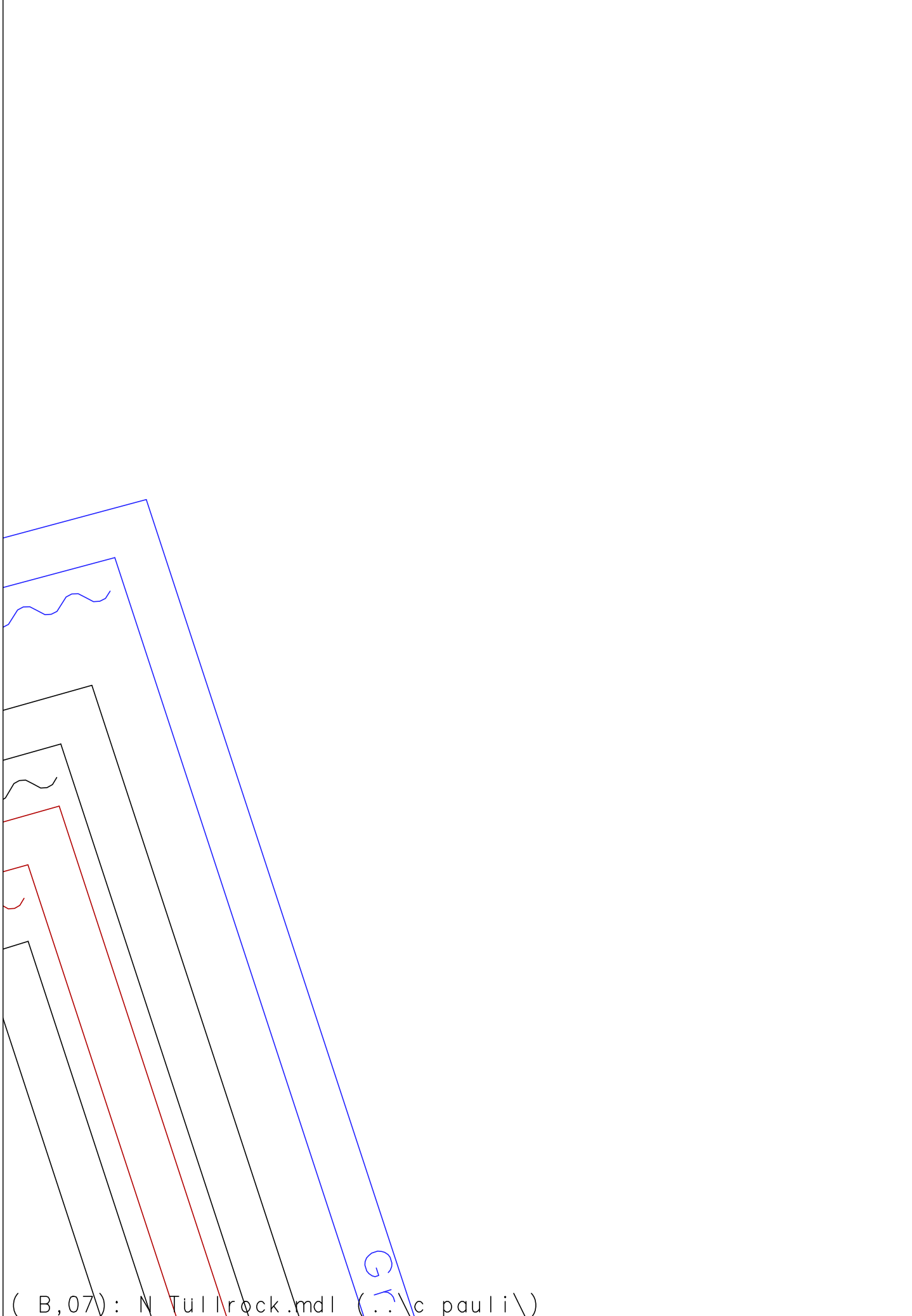

(B,07): N Tullrock.mdl (..\c pauli\)