

Große: 110. / 116.

Große: 122. / 128.

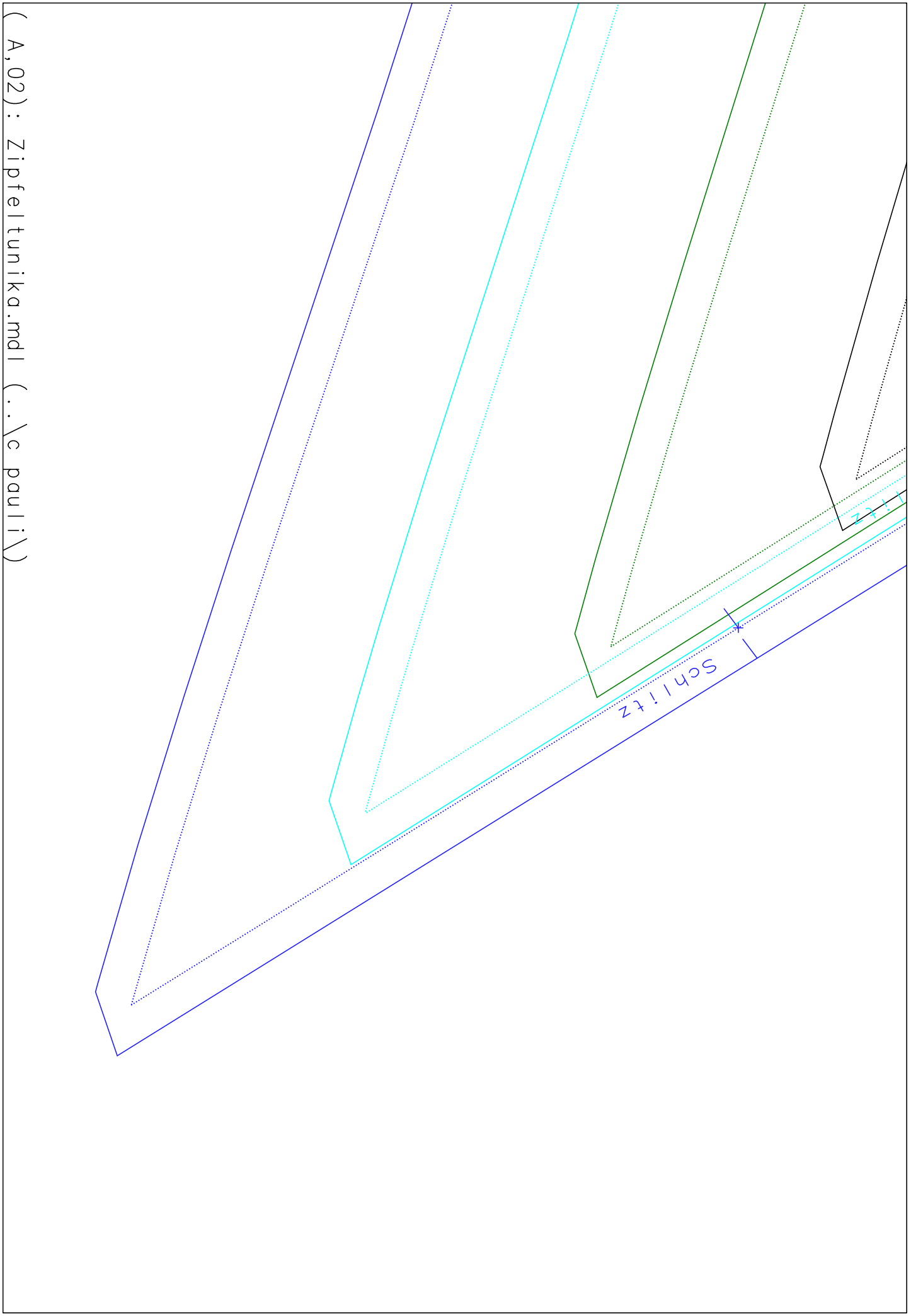

(A,02) : Zipfeltaunika.mdl (..\c pauli\)

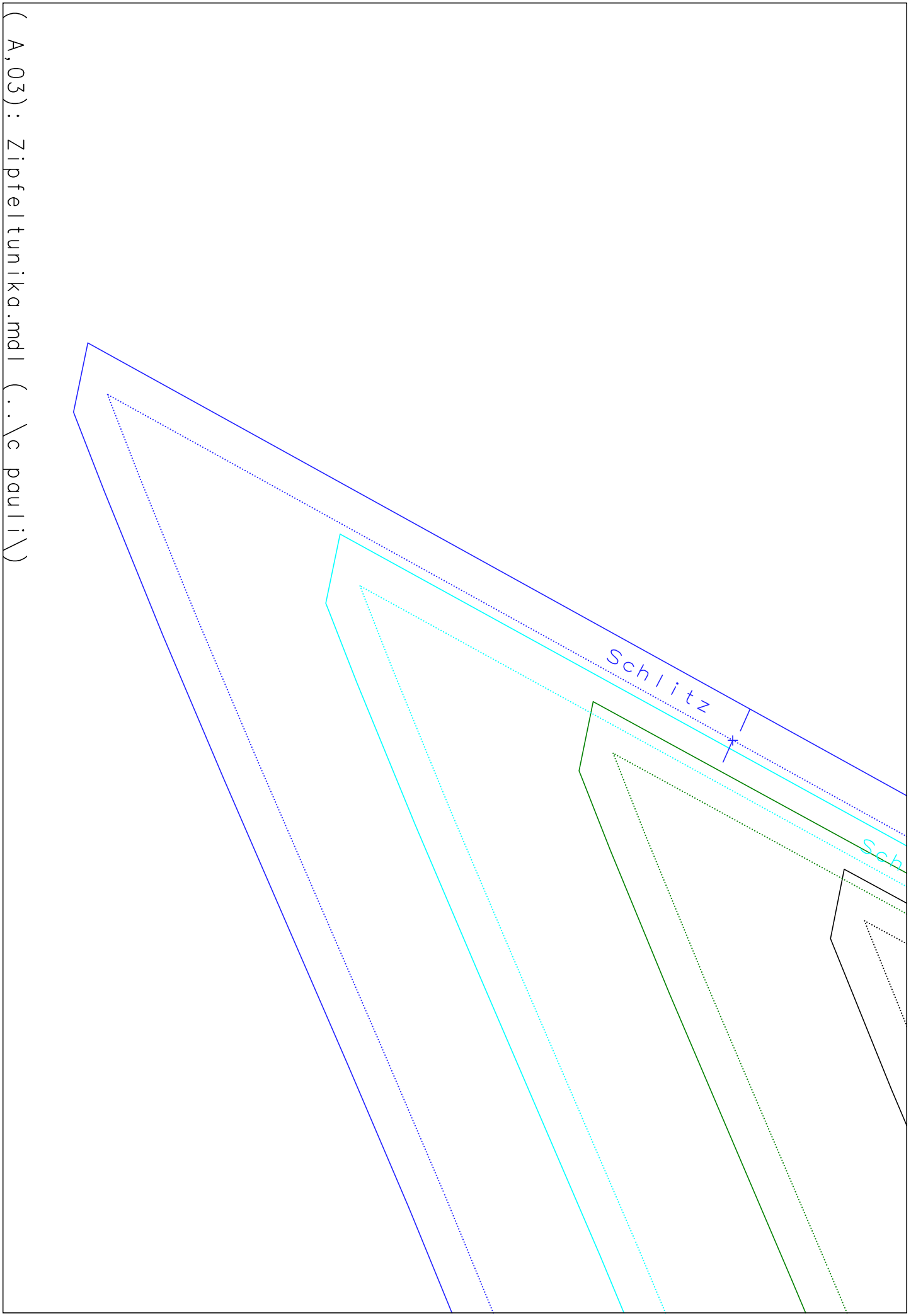

(A,03): Zipfeltaunika.mdl (..\c pauli\)

Größe: 122. / 128.

(A,04): Zipfel tunika.mdl (..\c pauli\)

Vordere Mitte

Zipfeltunika
1= Vorderteil

Große:

86. /

92.

Große:

98. /

104.

(B,01): Zipfeltunika.mdl (..\c pauli\)

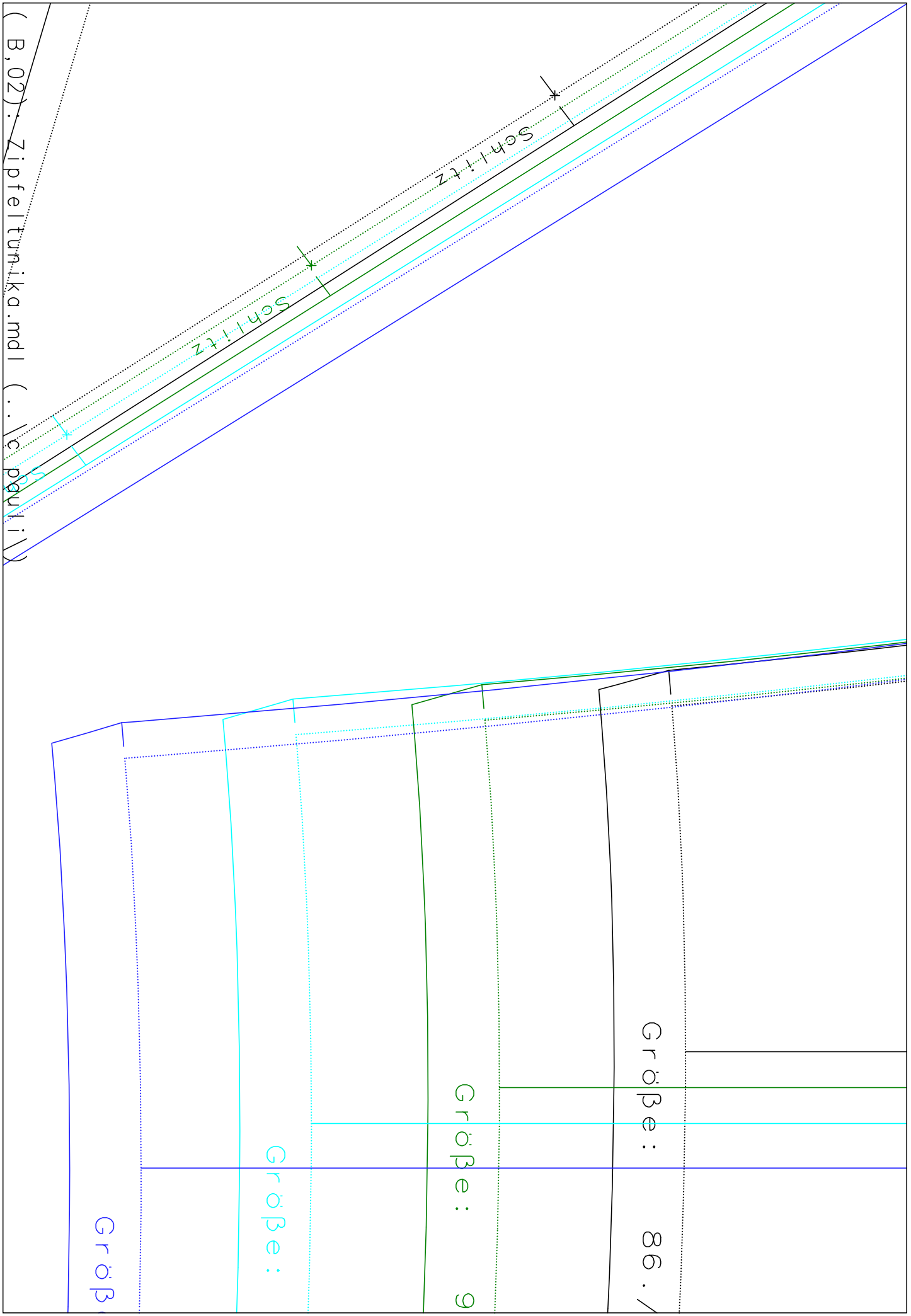

(B, 02): Zipfeltaunika.mdl (..\c pouli\)

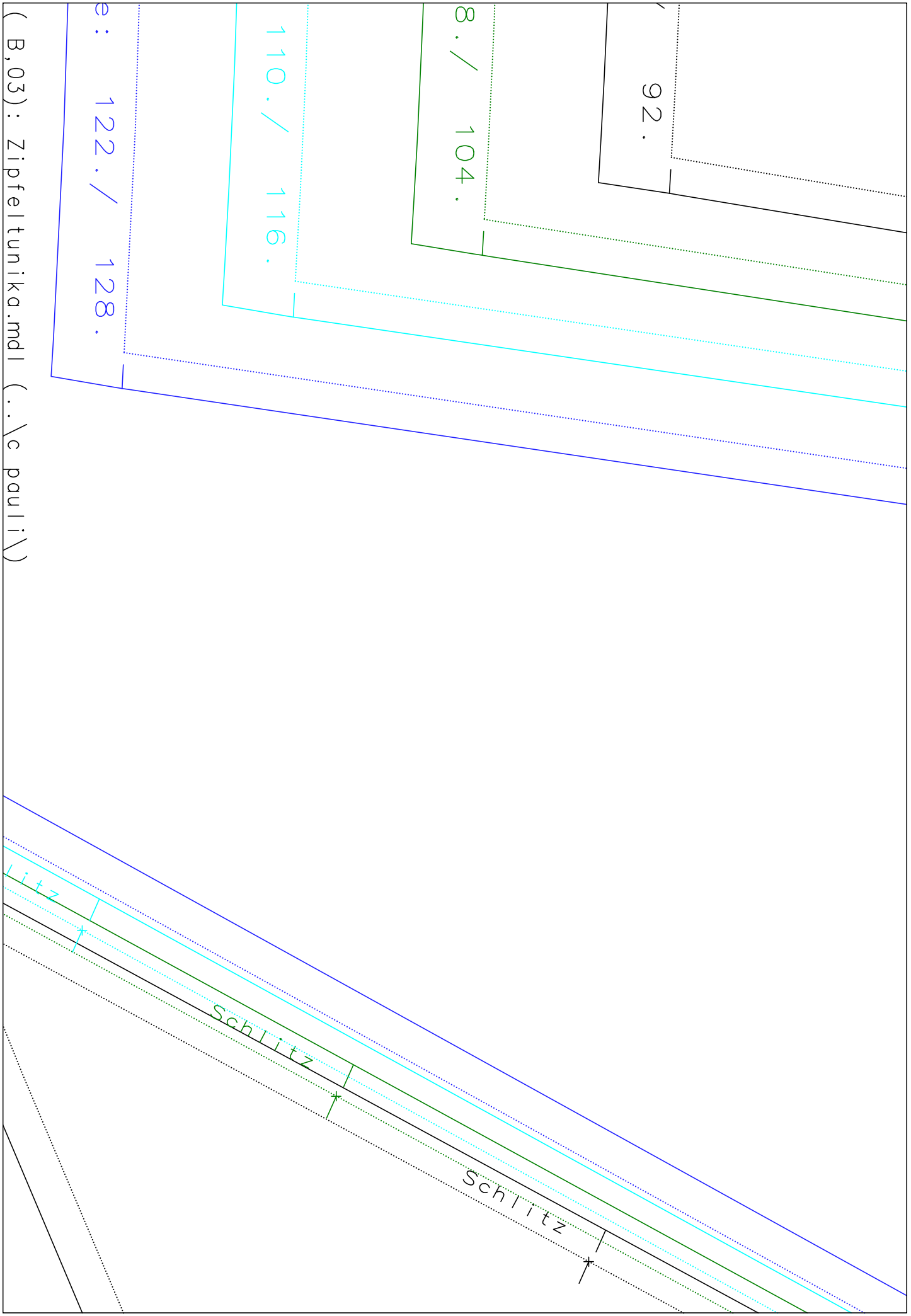

(B,03): Zipfelftunika.mdl (..\c pauli\)

Zipfunktunika 2 = Ruckenteil

Hinte

Größe: 86. / 92.

Größe: 98. / 104.

Größe: 110. / 116.

(B, 04) : Zipfunktunika.mdl (..\c pauli\)

(c,01) : Zipfeltaunika.mdl (..\c pauli\)

/ Stoffbruch / Fadenlauf

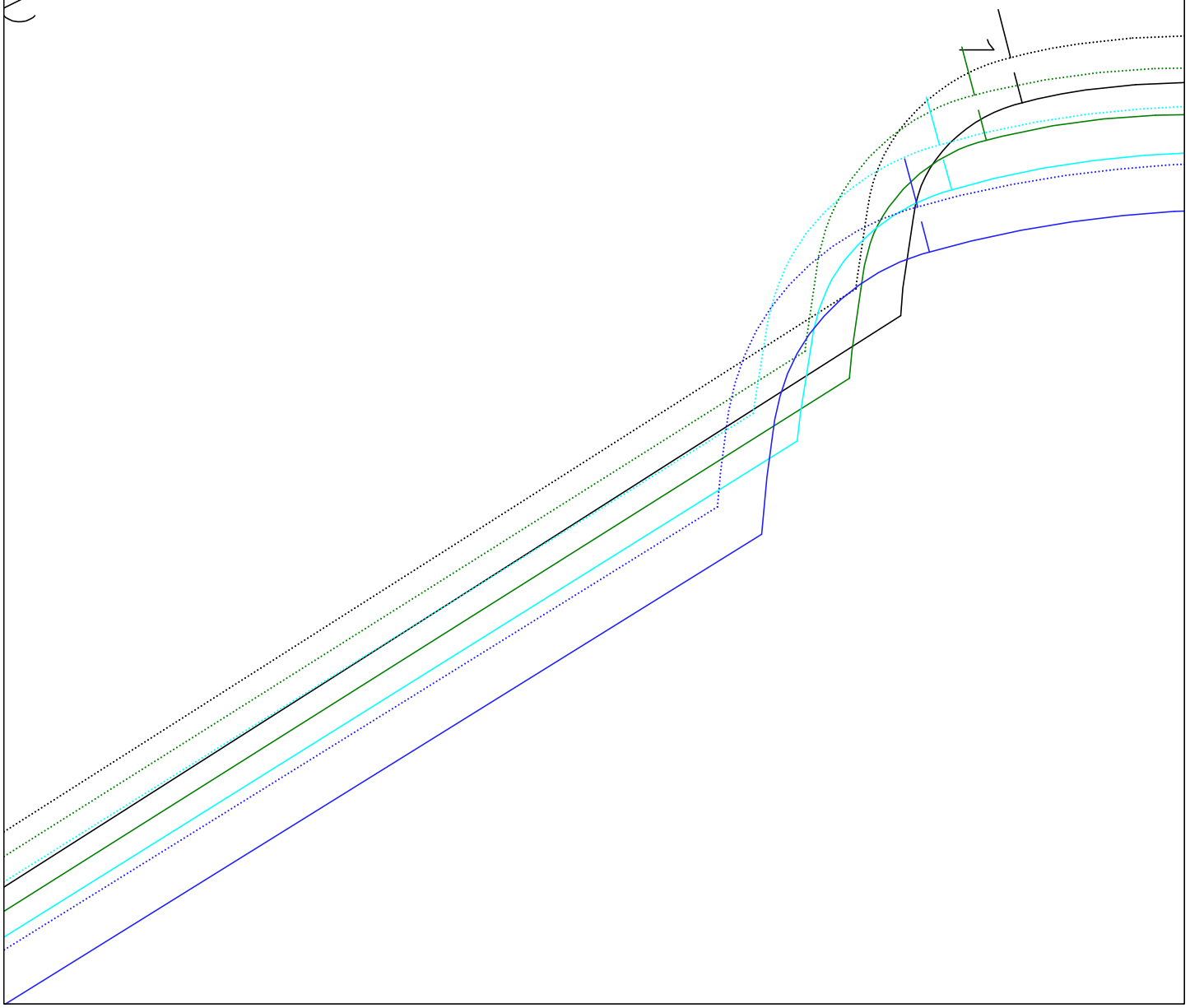

Zipfeltunika
3= Ärmel

Fadenlauf

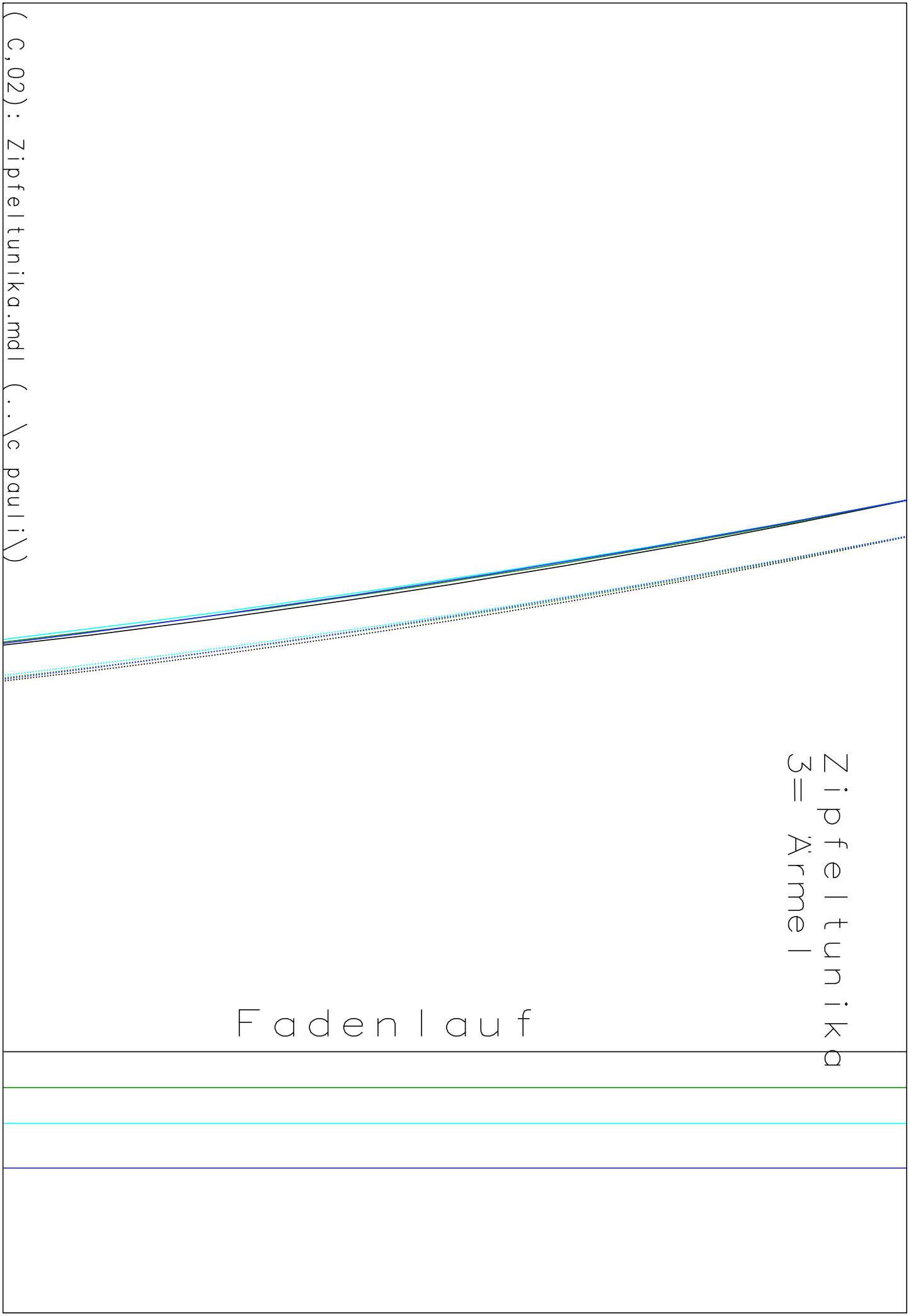

(c,02): Zipfeltunika.mdl (..\c pauli\)

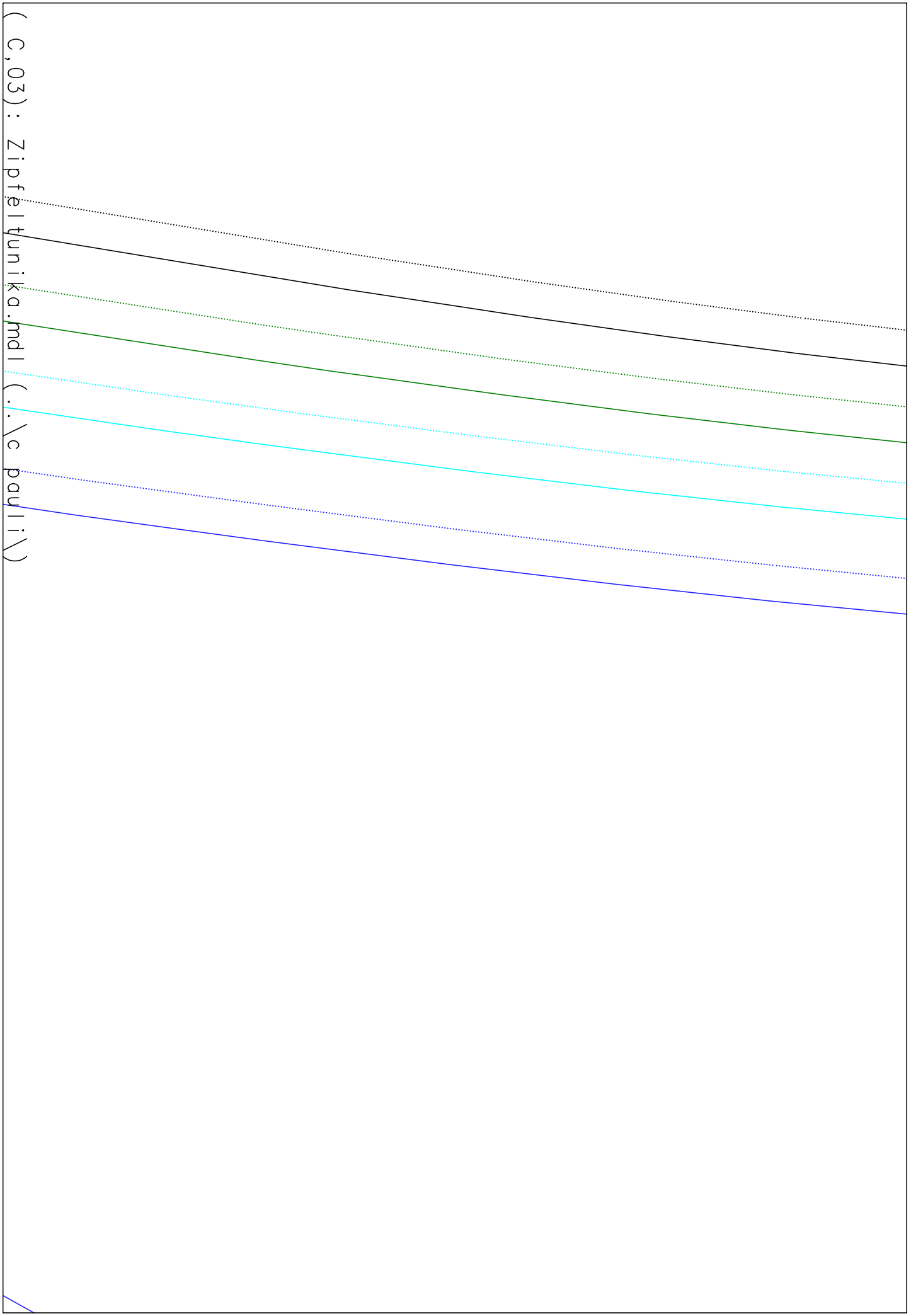

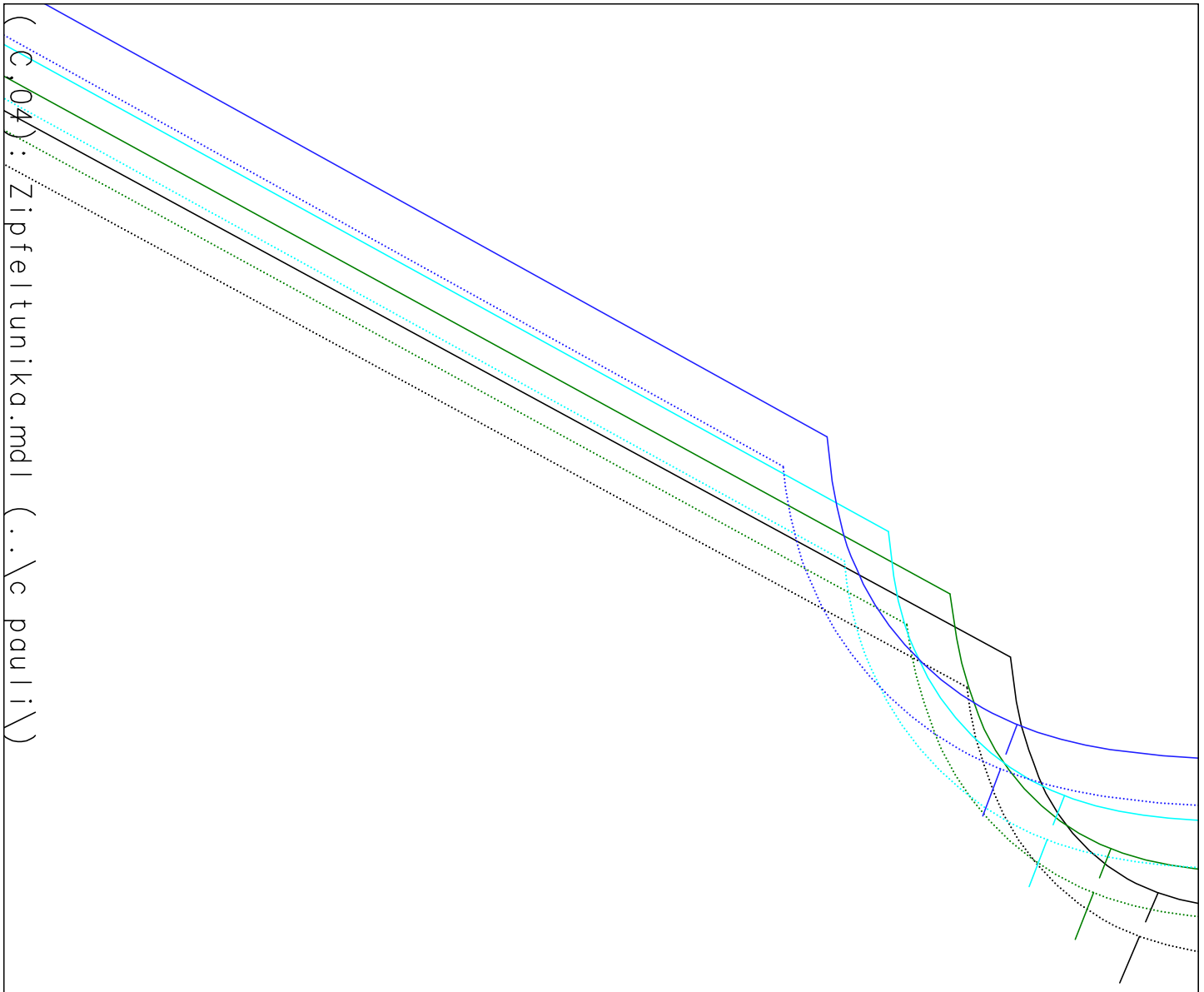

re Mitte / Stoffbruch / Fad

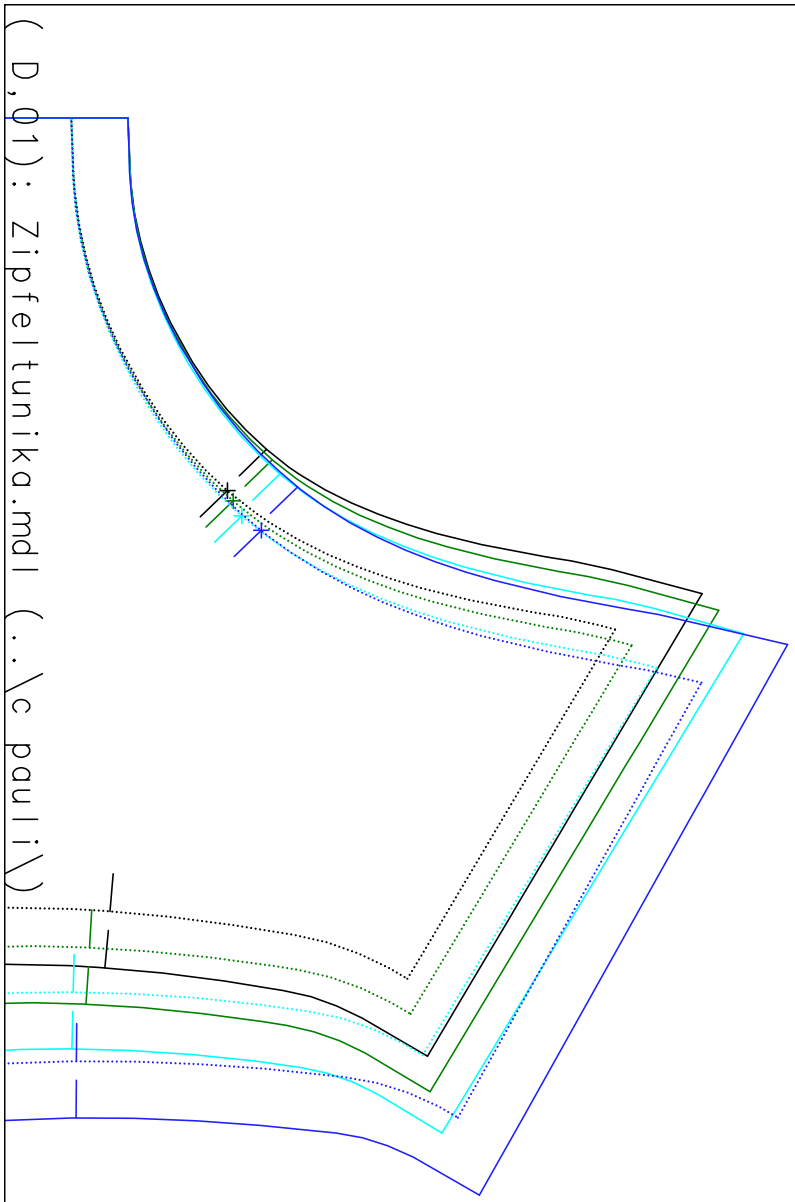

(D,01): Zipfeltaunika.mdl (..\c pauli\)

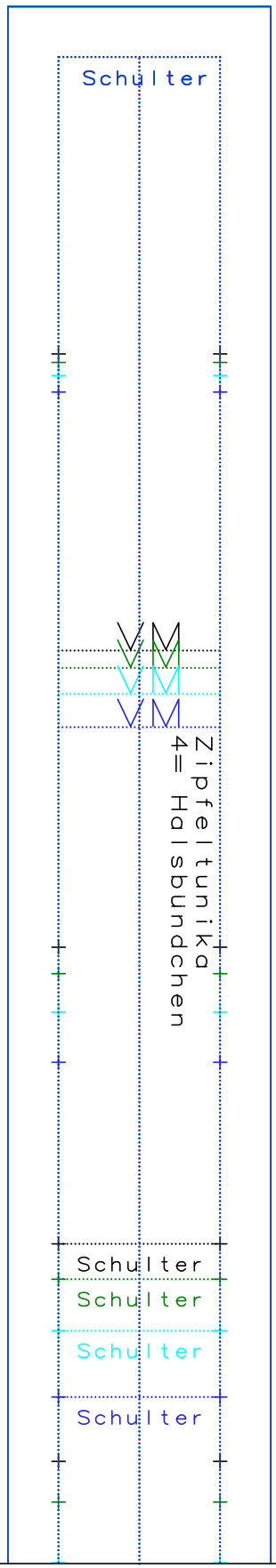

Schulter

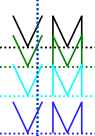

Zipfeltaunika
4= Halsbündchen

Schulter

Schulter

Schulter

Schulter

(D,02) : Zipfeltaunika.mdl (..\c papu11\)

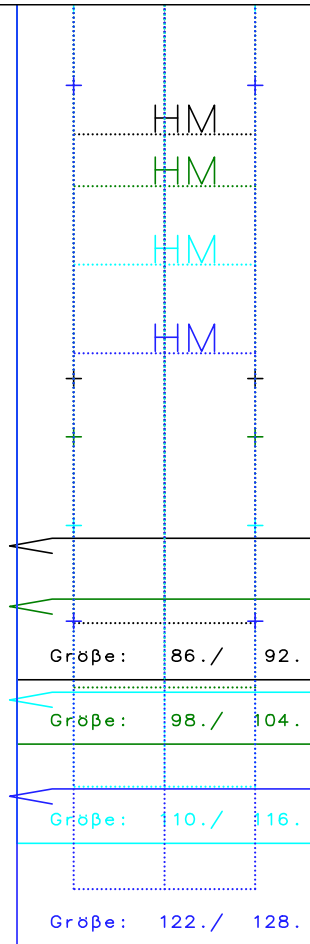
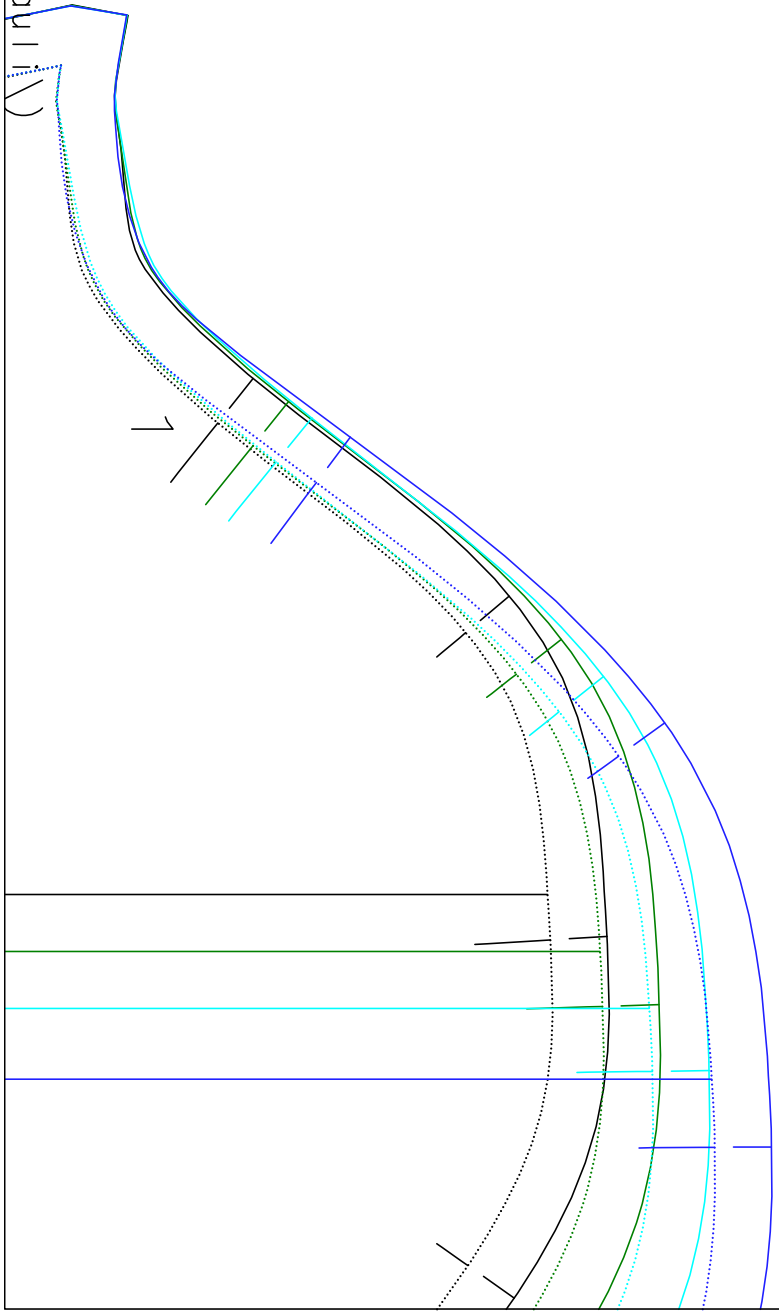

Zur eigenen Sicherheit:
Kontrollfenster nachmessen!

Seitenlänge 10 cm
4 inches

Copyright c.pauli GmbH

Größe:	86. /	92.
Größe:	98. /	104.
Größe:	110. /	116.
Größe:	122. /	128.

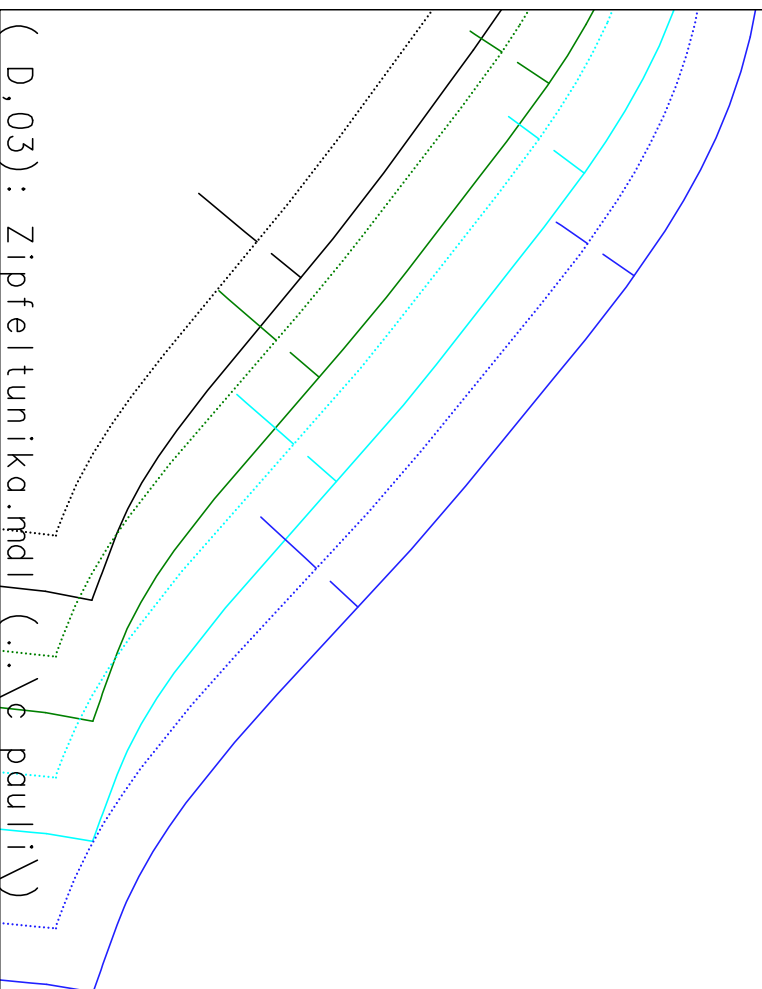

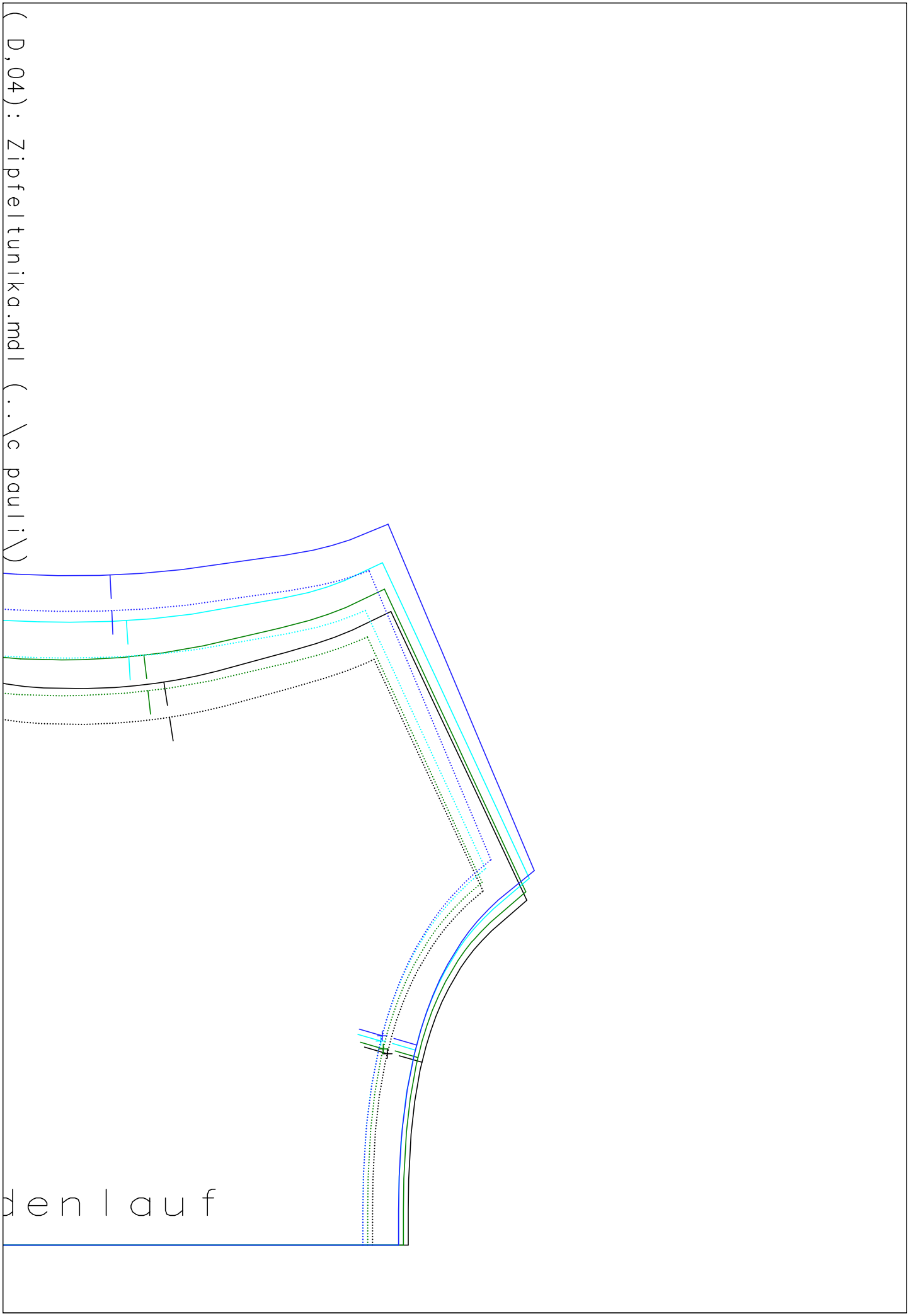

(D, 04) : Zipfeltaunika.mdl (..\c pauli\)

denlauf