

(A, 01) : Shorts.ind

copyright c.pauli

Shorts
Vorderhose

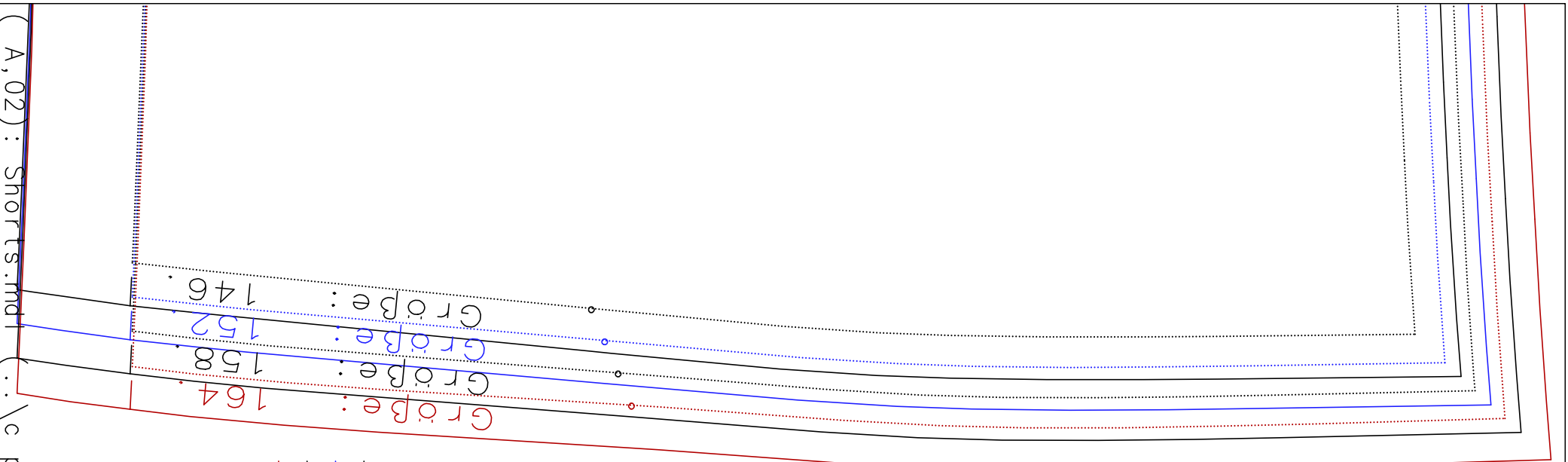

copyright c.pauli

Zur eigenen Sicherheit:
 Kontrollfenster nachmessen!
 Seitenlänge 10 cm
 4 inches

Größe:	146.
Größe:	152.
Größe:	158.
Größe:	164.

(A,02): Shorts.ind | c.pauli |

(A,03) : Shorts.mdl (..\c pauli\)

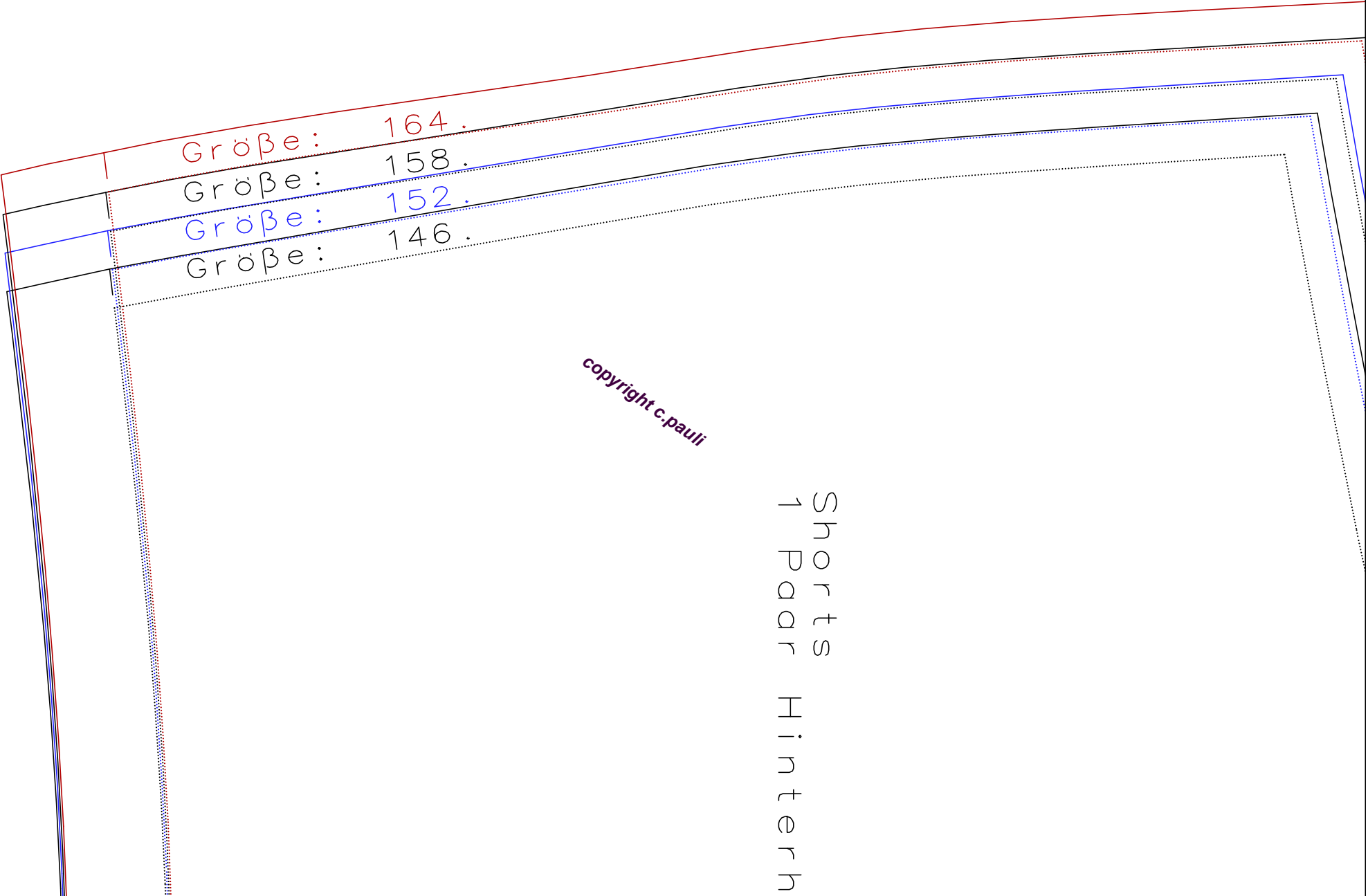

Größe: 164.
Größe: 158.
Größe: 152.
Größe: 146.

copyright c.pauli

Shorts
1 Paar
Hinterh

OSE

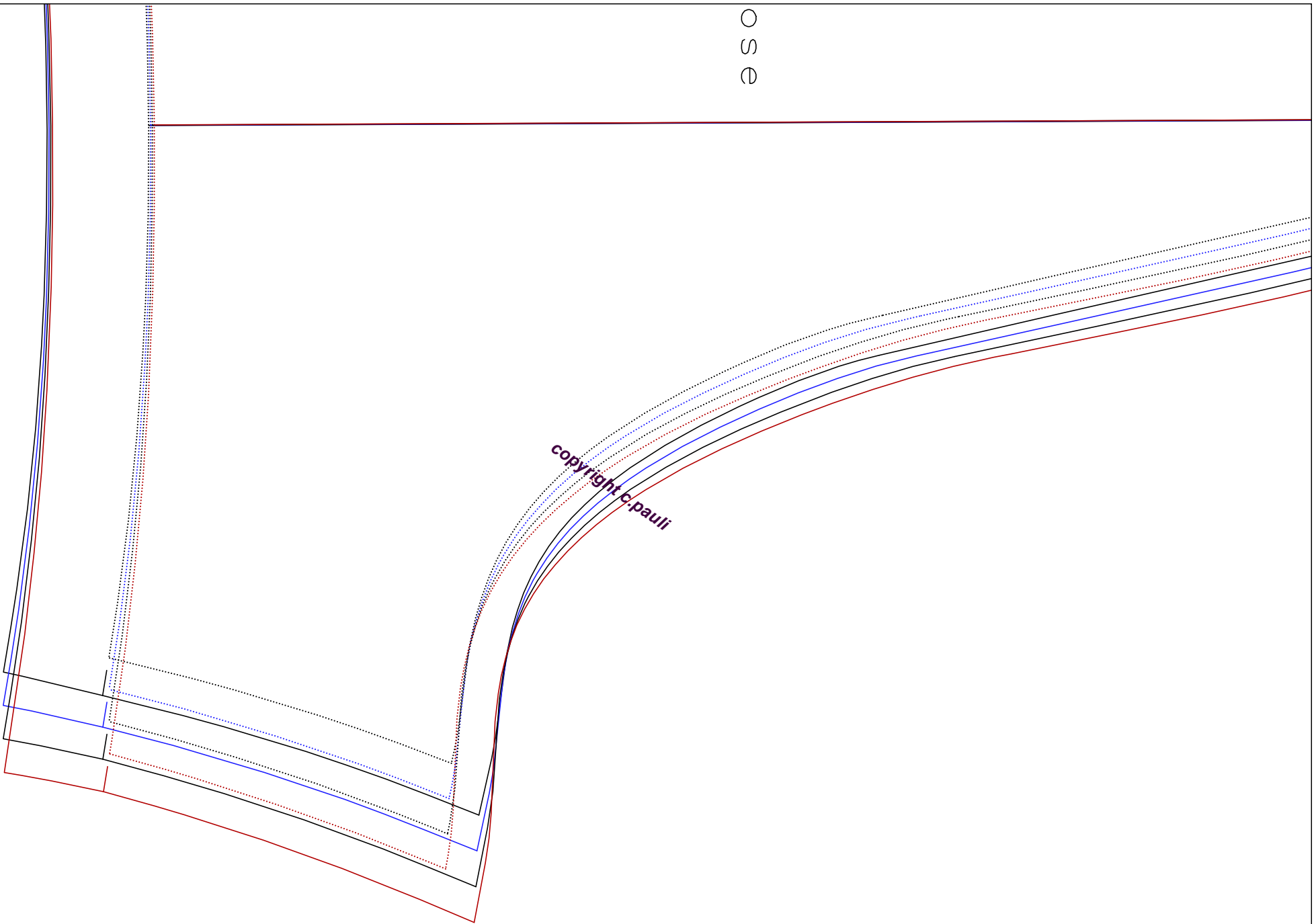

(A, 04) : Shorts.mdl (..\c pauli\)

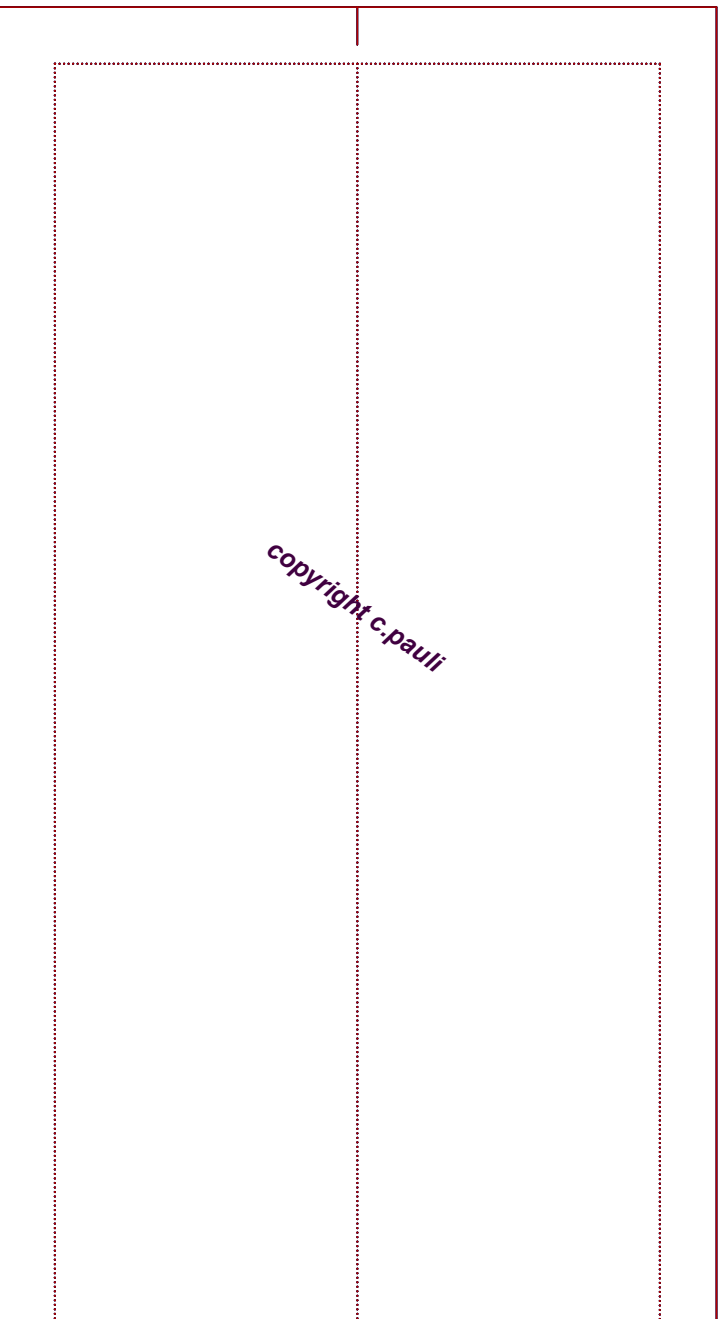

(B,01): Shorts.mdl (..\c pauli\)

Shorts 1x Bund Strick

copyright c.pauli

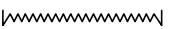
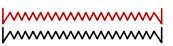
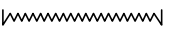
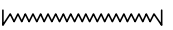

copyright c.pauli

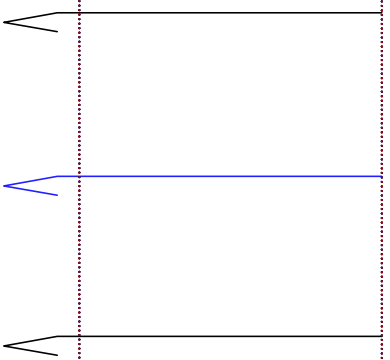

(B, 03) : ~~Sherts.md~~ (~~c.pauli~~)

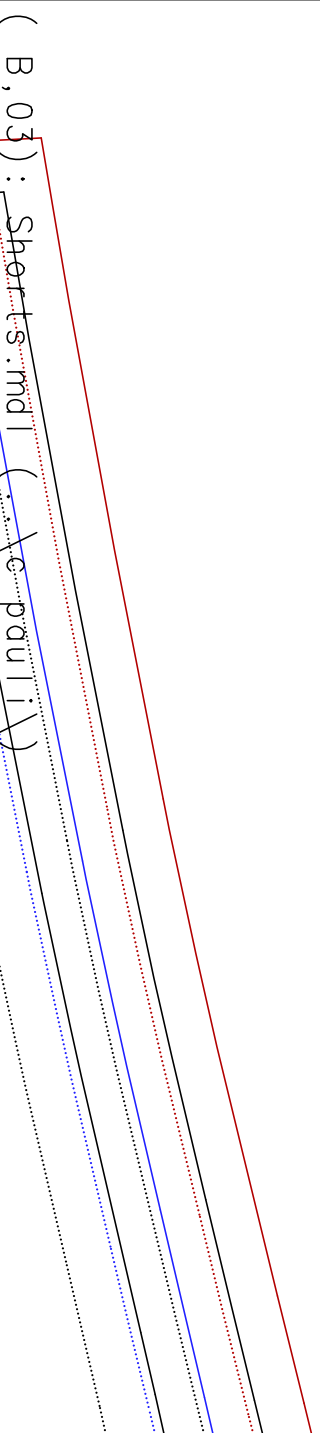

	Größe:	146.	
	Größe:	152.	
	Größe:	158.	
	Größe:	164.	

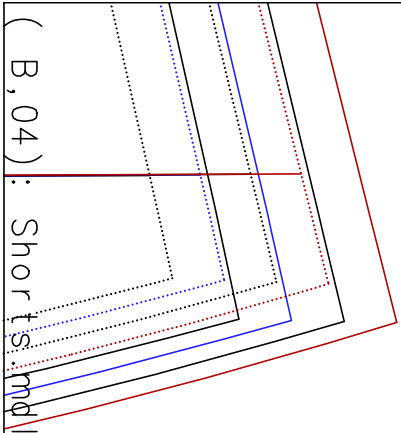

(B,04): Shorts.mdi (..c pauli)

copyright c.pauli